

專精半導體自動測試設備解決方案 (德國製)

Test Equipment for The Semiconductor Industry

- 自動化測試配件傳送設備暨創新客製化測試設備接合機構解決方案
- 可廣泛應用於不同種類的 IC 自動測試機，分類機 / 晶圓針測機
- 自動化測試配件儲存系統
- 易於產線快速佈署並提供最佳可靠性暨最低維護成本

ATE Trolleys 測試機&配件傳送設備

- Testheads Weighing 275kg ~ 750kg
- Mobile Manipulator 廣泛支援主流 IC 自動測試機 (Advantest, Teradyne, Cohu, NI ..etc)
- 支援專利 TD P-Docking 接合技術 (SemiAuto Docking Mechanism, Docking Force >450kg)



Universal Trolley
通用推車

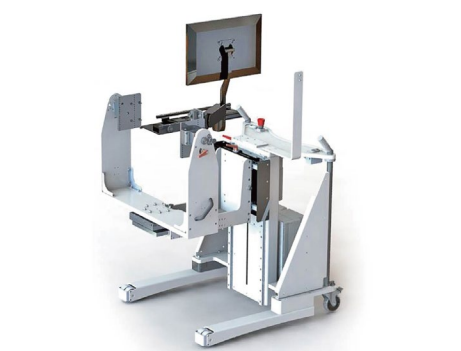

Final Test Trolley
FT推車

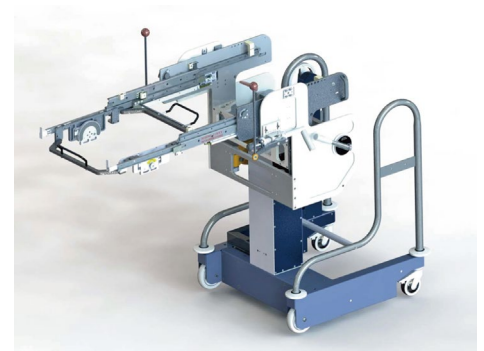

Probecard Trolley
探針卡推車

ATE Manipulator 通用型機械手臂

- Testheads Weighing 120kg ~ 500kg
- 廣泛支援主流 IC 自動測試機 (Advantest, Teradyne, Cohu, NI ..etc)
- 支援專利 TD P-Docking 接合技術 (SemiAuto Docking Mechanism, Docking Force >450kg)



TDM10



TDM20



TD2080

ATE Docking Systems 測試機連結系統

- 廣泛支援主流IC自動測試機 (Advantest, Teradyne, Cohu, NI ..etc)
- 專利 TD P-Docking 接合技術 (SemiAuto Docking Mechanism, Docking Force >450kg)
- 高效能接合設計有效提升測試系統機構穩定性暨降低維護成本

CP Direct Docking

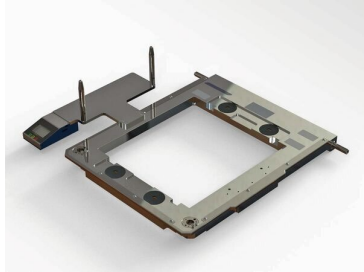

Direct Docking for
8" Probers

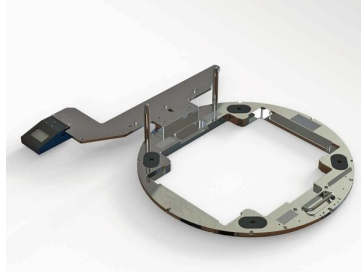

Direct Docking for
12" Probers

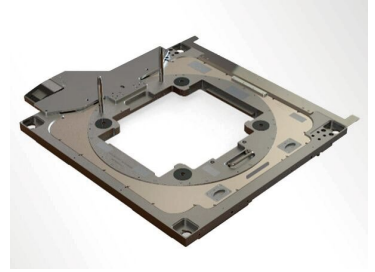

Universal Prober
Head Plate

Final Test Handling

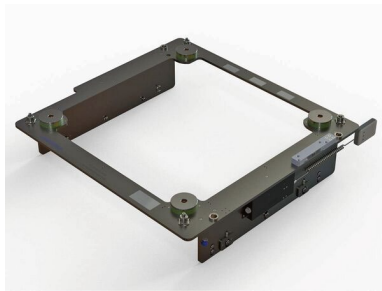

P-Dock® Systems

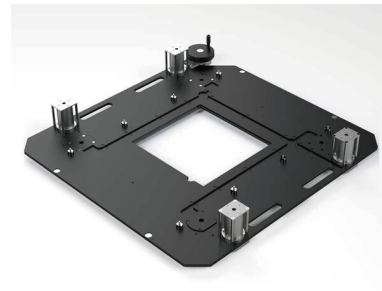

F-Dock Systems

Storage System 測試配件儲存系統

- 全自動取放裝置設計提供高價值測試配件安全穩定儲存環境
- 搭配Trolleys半自動配件傳送設備有效保護高價值測試配件並降低人為操作損害

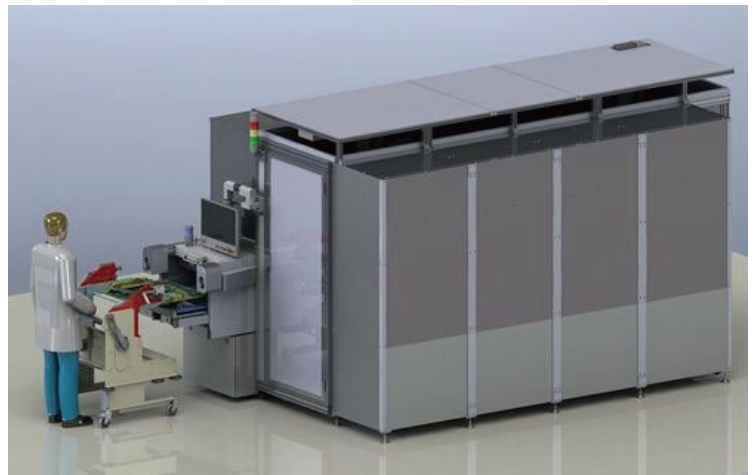

Contact us

📍 新竹市東區水源街95號
☎ +886 3 573 8099 #1078
✉ marketing@spirox.com

